

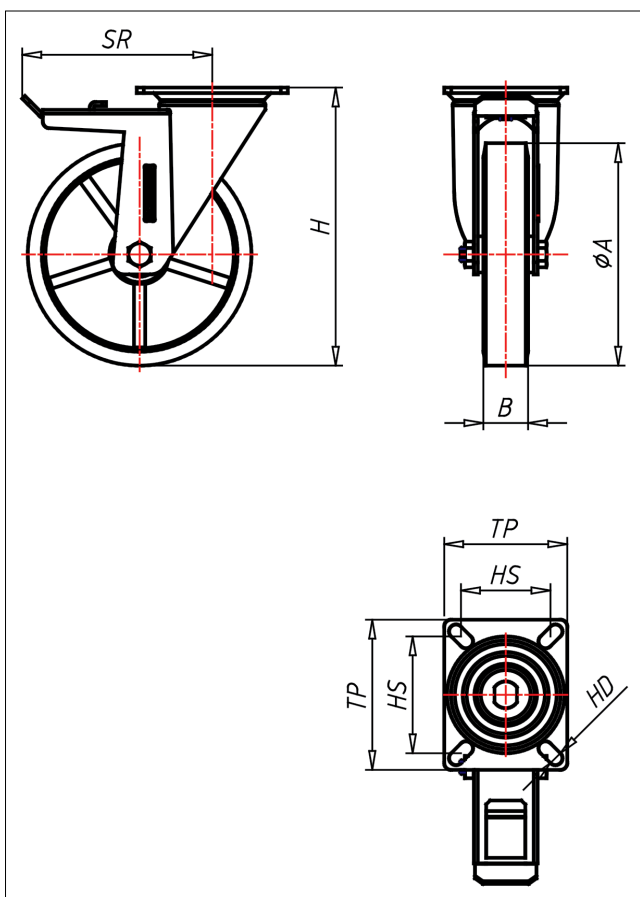

# PDT/PST-ZK/LZK

## Lenkrolle mit Totalfeststeller

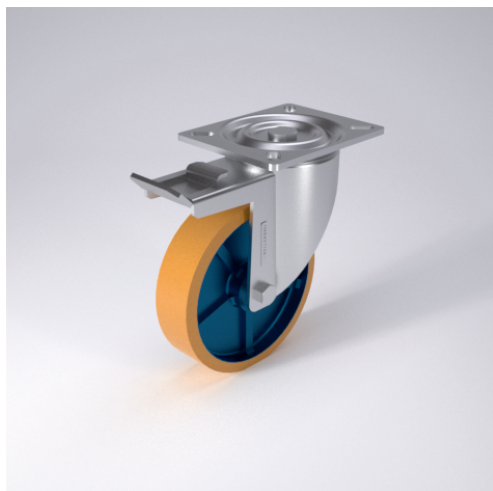

### PD-Z



LENKROLLE	LENKROLLE MIT TOTALFESTSTELLER	BOCKROLLE																				
<ul style="list-style-type: none"> <li>• geräuscharmer Lauf</li> <li>• geringer Rollwiderstand</li> <li>• abrieb- und reißfest</li> <li>• hohe Stoßfestigkeit</li> <li>• sehr beständig gegen viele aggressive Medien</li> </ul> <p>Guss-Polyurethan Felge Gussisen lackiert → Seite 245</p>	<p>gehärtete Stahlkugeln, zweifache Kugelbahnen aus gehärtetem Stahlblech, mit starkem Zentralzapfen verschraubt und gesichert - nachstellbar</p> <p>→ Seite 42</p>	<p>AUSWAHLHILFE:</p> <table border="1"> <tr> <td>leicht lenkend</td> <td>+</td> <td>x</td> <td>++</td> </tr> <tr> <td>verschleißarm</td> <td>+</td> <td>x</td> <td>++</td> </tr> <tr> <td>stoßfest</td> <td>+</td> <td>x</td> <td>++</td> </tr> <tr> <td>bodenschonend</td> <td>+</td> <td>x</td> <td>++</td> </tr> <tr> <td>witterungsbeständig</td> <td>+</td> <td>x</td> <td>++</td> </tr> </table>	leicht lenkend	+	x	++	verschleißarm	+	x	++	stoßfest	+	x	++	bodenschonend	+	x	++	witterungsbeständig	+	x	++
leicht lenkend	+	x	++																			
verschleißarm	+	x	++																			
stoßfest	+	x	++																			
bodenschonend	+	x	++																			
witterungsbeständig	+	x	++																			

### Technische Details

ORDERNO (Artikel-nummer)	PDT 150 ZK
WDAB (Rad-Ø A x Breite B / mm)	150x40
LC (Tragkraft / kg)	450
H (Bauhöhe H / mm)	195
TP (Plattengröße / mm)	135x110
HS (Lochabstand / mm)	105x80
HD (Loch-Ø / mm)	10.5
SR (Schwenkradius / mm)	140
WB (Radlager)	Kugellager